

Denoising of Electrocardiogram Data with Methods of Wavelet Transform

Galya Georgieva-Tsaneva, Krassimir Tcheshmedjiev

Abstract: A new adaptive thresholding method for denoising of electrocardiography (ECG) signals using Wavelet Transform has been investigated. An improvement of the classical denoising technique has been proposed by implementing a new subband dependent threshold. The proposed algorithm has been tested with ECG signals (MIT-BIH Arrhythmia Database) with added standard Gaussian noise. Valuation parameters are calculated to determine the effectiveness of the presented algorithm. The obtained results show that the proposed denoising algorithm could be applied to electrocardiography signals.

Key words: electrocardiography signal, Wavelet Transform, denoising, threshold, shrinkage, Signal to Noise Ratio, Mean Square Error.

1. INTRODUCTION

The noise reduction in electrocardiography signals is one of the important problems, which appear during the analysis of ECG data. ECG signal is non-stationary biological signal in nature and plays a big role in diagnostics of human diseases. Therefore the electrocardiography signals need an effective denoising [1].

The most common sources of noise containing frequency components within ECG spectrum are [9]:

- power line interference;
- baseline drift and motion artefacts;
- electrical activity of muscles (EMG);
- instability of electrode-skin contact;
- instrumentation and electrosurgical noise.

Wavelet transform has been used in removing noise from the biological signals because of its good localization properties in time and frequency domain [6, 11]. Several different multiresolution schemes have been proposed, among which wavelet based methods are the most popular [2, 5, 12]. The analysis of Medical signals based on WT and Fractal Analysis is subject of an actual research work, published recently [1, 7, 8, 11].

The proposed signal denoising algorithm in this paper is based on the method of Johnstone and Donoho [3, 4]. It has been proven that this method has been successfully applied to a wide class of non-stationary signals [1]. The threshold values are used to smooth out or to remove some detailed wavelet coefficients of the original signal. The obtained noiseless signal is then reconstructed in time domain using the modified coefficients. Threshold determination is a very important issue, since shrinkage affects significantly the quality of ECG morphology.

The problem of denoising is then formulated into finding the optimum wavelet basis functions and the optimum threshold for the noising signal.

The aims of this article are:

1. Presentation of a modified algorithm for denoising of the ECG signal with wavelet transform and adaptive shrinkage method.
2. Estimate the reconstruction signal with Mean Square Error, Signal to Noise Ratio etc.
3. Comparative analysis between the results obtained by applying on proposed denoising method to find the best wavelet basis and decomposition level.
4. Using different ECG signals to verify the presented method.

2. METHODOLOGY

The model of a discrete noisy signal is the superposition of the signal $f(t)$ and a zero mean Gaussian white noise with a variance of σ^2 : $\eta(0, \sigma^2)$ [1]:

$$s(t) = f(t) + e(t), \quad (1)$$

where: $s(t)$ – observed signal, $f(t)$ – free noise signal, $e(t)$ – noise.

The general algorithm for wavelet shrinkage denoising consists of the following steps [4]:

1. Noise generation and addition: A white noise is generated and added to the original signal (formula (1)).
2. Applying discrete wavelet transform on the observed noise signal and obtaining wavelet coefficients at scale l , where $l = 1, 2, 3, \dots, L$.
3. A thresholding is used to shrink the resulting wavelet detail coefficients of the noisy signal.
4. Applying inverse discrete wavelet transform on the resultant coefficients (reconstruction) to obtain an estimation of the signal.

Donoho and Johnston proposed the universal threshold, called by them “Wave Shrink” [4], given by:

$$\delta = \sigma \sqrt{2 \log(N)}, \quad (2)$$

where: N – total number of points; σ - standard deviation.

In the case of white noise, σ can be estimated from the median of detail coefficients:

$$\sigma = \frac{MAD}{0.6745}, \quad (3)$$

where: $MAD = \text{median}(|d(j, k)|)$ - median absolute deviation of detail coefficients of level j ;

$d(j, k)$ - detail coefficients of level j .

3. ALGORITHM DESCRIPTION

The paper proposes an algorithm to denoising of ECG data, which uses the Wavelet Transform, the adaptive soft thresholding shrinkage and modification of Donoho's formula. The algorithm decomposes the original signal through the DWT and processes the resulting detail coefficients using an optimal threshold value.

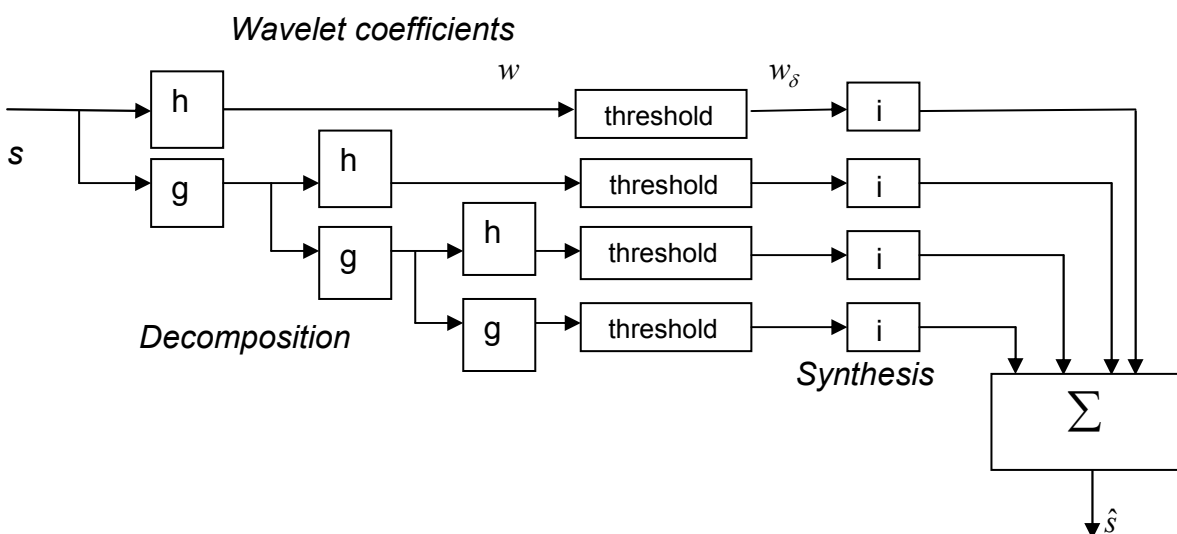

Figure 1. Model of the adaptive algorithm for denoising: h - high-pass filters; g – low-pass filters; i – inverse filters

Principle of the method: For each level of decomposition of the signal a different threshold is selected, which is the most suitable (for a particular level) in terms of the optimal removal the noise components (figure 1).

The Wavelet Coefficients are compared with an adaptive threshold value. For each level of decomposition the threshold δ is calculated using the formula proposed:

$$\delta_j^\mu = \frac{1}{\mu_j} \sigma_j \sqrt{2 \log(N_j)} , \quad (4)$$

which is a new modification of Donoho's formula (2).

The parameter μ_j is calculated according to the proposed formula:

$$\mu_j = \max(|d(j, k)|) \quad (5)$$

Where:

$d(j, k)$ - detail coefficients at the corresponding level of decomposition;

j - level of decomposition;

k - current index.

The signal is reconstructed using the modified detail coefficients and unchanged approximation coefficients. Valuation parameters are calculated to determine the effectiveness of the proposed algorithm.

4. EVALUATION OF THE ALGORITHM

The implementation of this method is evaluated based on the parameters [6, 10, 11] referred in Table 1 ($s(n)$ - clean signal; $\tilde{s}(n)$ - denoised signal).

Table 1

SNR_{db} Signal to Noise Ratio	$10 \cdot \log_{10} \frac{\sum_{n=0}^{N-1} s(n)^2}{(s(n) - \tilde{s}(n))^2}$ (6)
MSE Mean Square Error	$\frac{1}{N} \sum_{n=0}^{N-1} (s(n) - \tilde{s}(n))^2$ (7)
$NMSE$ Normalized Mean Square Error	$\frac{1}{N} \sum_{n=0}^{N-1} (s(n) - \tilde{s}(n))^2$ (8)
$RMSE$ Root Mean Square Error	$\sqrt{\frac{1}{2N} \sum_{n=0}^{N-1} (s(n) - \tilde{s}(n))^2}$ (9)
$PSNR$ Peak Signal to Noise Ratio	$10 \log_{10} \frac{255}{\frac{1}{N} \sum_{n=1}^N s(n) - \tilde{s}(n) }$ (10)
PDR Percentage Root Mean Square Difference	$\sqrt{\frac{\sum_{n=0}^{N-1} [s(n) - \tilde{s}(n)]^2}{\sum_{n=0}^{N-1} [s(n)]^2}} \cdot 100\%$ (11)

5. RESULTS

This paper proposes a new relation to finding the threshold value. Evaluation of many signals for validity is required. The proposed algorithm is tested on AHA (American

Heart Association) ECG database [13]. This database contains a set of ECG data records sampled at a rate of 360 Hz with 11 bit resolution over a 10 mV range. The studied original ECG signal (with the number of a sample points $N=1024$) is shown in Figure 2. In this research the orthogonal wavelet functions: Haar, Daubechies: Db4, Db6, Db8, Db10, Db12 and Db20 are studied. Gaussian white noise is added to the original signal. The noisy ECG signal is shown in Figure 3. DWT is applied to the noisy signal at all possible levels of decomposition (scale l). After determining the threshold value (for each level with the proposed formula (4)) the wavelet detail coefficients are filtering (with soft adaptive thresholding). The Inverse DWT is applied on the resultant approximate and detail coefficients, and denoised signal estimate is obtained. The reconstruction denoised ECG signal is shown in Figure 4. Figure 5 shows the noise extracted from ECG signal using traditional adaptive soft method algorithm based on wavelet shrinkage with formula (3).

The new noise reduction procedure has been implemented in Visual C++. The effectiveness of the denoising process for different orthogonal wavelet basis functions (mentioned above / aforementioned) has been tested. With the optimal basis Db12 are investigated different levels of decomposition (levels 1 to 10). The DWT denoising is performed and the threshold is computed with formula (4).

Figure 6 shows the noise extracted from ECG signal using the new adaptive algorithm based on wavelet thresholding (threshold computed with formula (4)).

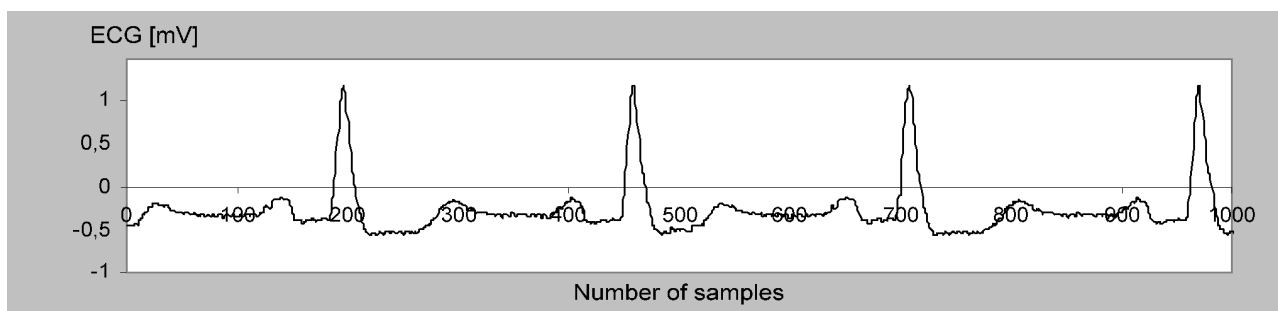

Figure 2. Original ECG signal

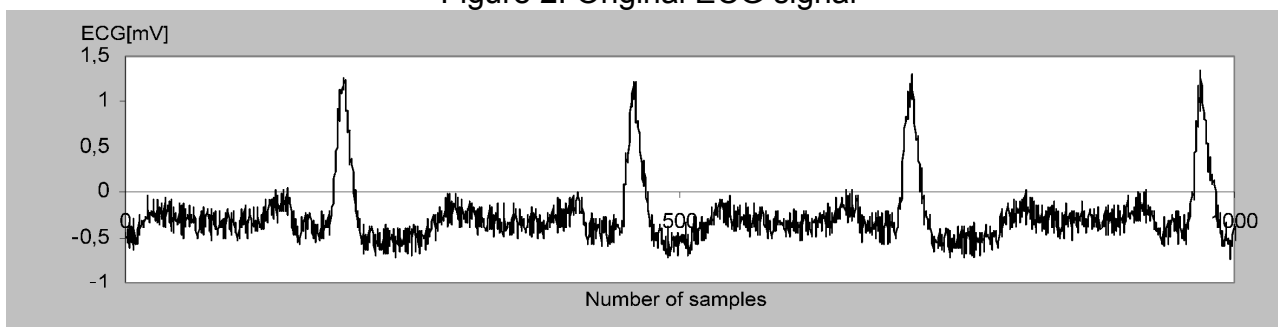

Figure 3. Noise ECG signal

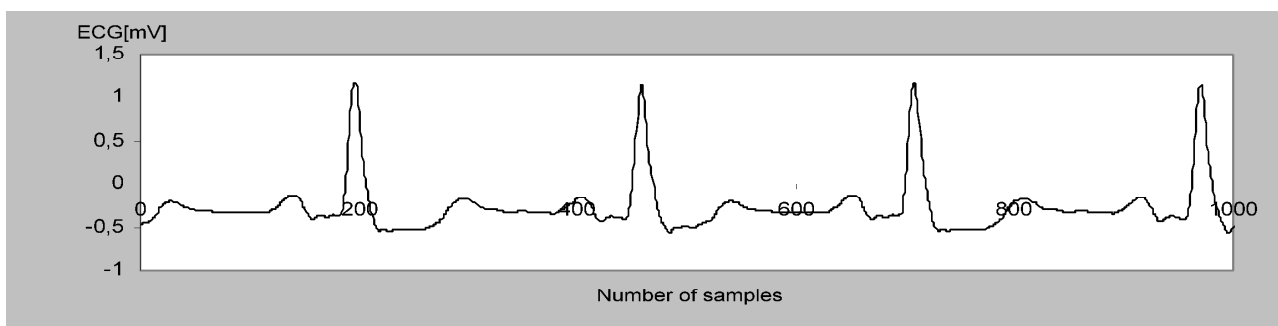

Figure 4. Denoised ECG signal with proposed method

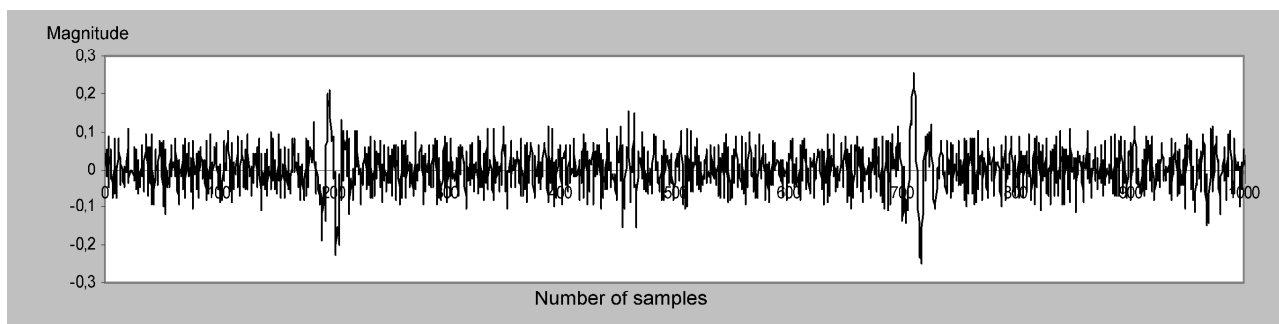

Figure 5. Noise extracted from ECG signal whit traditional adaptive soft threshold method

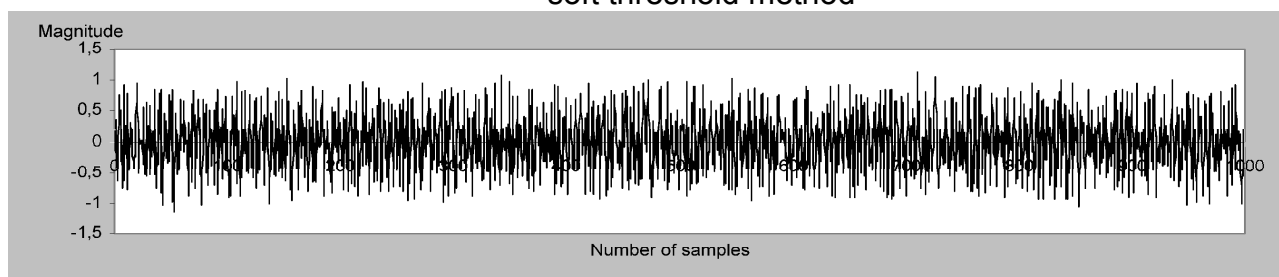

Figure 6. Noise extracted from ECG signal whit new adaptive soft threshold method

The Table 2 shows denoising results of original ECG signal (figure 1) using proposed method and different wavelet basis. The obtained results show Db12 basis as the optimal basis. In the Table 3 are presents denoising results using new algorithm, Db12 wavelet basis and different decomposition level.

Table 2. Denoising results using different wavelet basis

<i>WT</i>	<i>SNR</i>	<i>PSNR</i>	<i>MSE</i>	<i>NMSE</i>	<i>RMSE</i>	<i>PDR[%]</i>
<i>Haar</i>	3.503024	30.056777	0.142555	0.890631	0.266978	94.37
<i>Db4</i>	12.302335	45.878939	0.009420	0.058853	0.068629	24.25
<i>Db6</i>	11.424484	45.878939	0.011530	0.072036	0.075928	26.83
<i>Db8</i>	12.057204	45.878937	0.009967	0.062227	0.070594	24.95
<i>Db10</i>	11.324331	46.478188	0.011799	0.073717	0.076809	27.15
<i>Db12</i>	12.67483	45.878939	0.008646	0.054015	0.065748	23.24
<i>Db20</i>	11.515212	45.226716	0.011292	0.070547	0.075139	26.56

Table 3. Denoising results using Db12, different decomposition levels

<i>Level</i>	<i>SNR</i>	<i>PSNR</i>	<i>MSE</i>	<i>NMSE</i>	<i>RMSE</i>	<i>PDR[%]</i>
1	5.975432	60.916823	0.040433	0.252614	0.142186	50.26
2	8.928282	60.916835	0.020486	0.127870	0.101120	35.77
3	11.545562	60.916847	0.011213	0.070056	0.074877	26.46
4	12.67483	45.878939	0.008646	0.054015	0.065748	23.24
5	10.406461	60.916887	0.014576	0.090664	0.085370	30.17
6	6.032678	60.916884	0.039904	0.249306	0.141252	49.33
7	5.219411	60.916894	0.048122	0.300648	0.155116	54.83
8	3.440923	32.837096	0.072446	0.452801	0.190362	67.29
9	1.917495	30.890354	0.102928	0.643059	0.226857	80.19
10	1.109759	30.140423	0.123986	0.774505	0.248965	88.01

The resulting data in Table 2 show that the Db12, Db8 and Db4 wavelet basis achieve the most efficient denoising of the original ECG signal. Comparisons were drawn

about Mean Square Error and the Signal/Noise Ratio. The differences between the results obtained with the aforementioned wavelet basis are relatively small.

In Figure 6 are presents the results of the obtained CPU time for different basis.

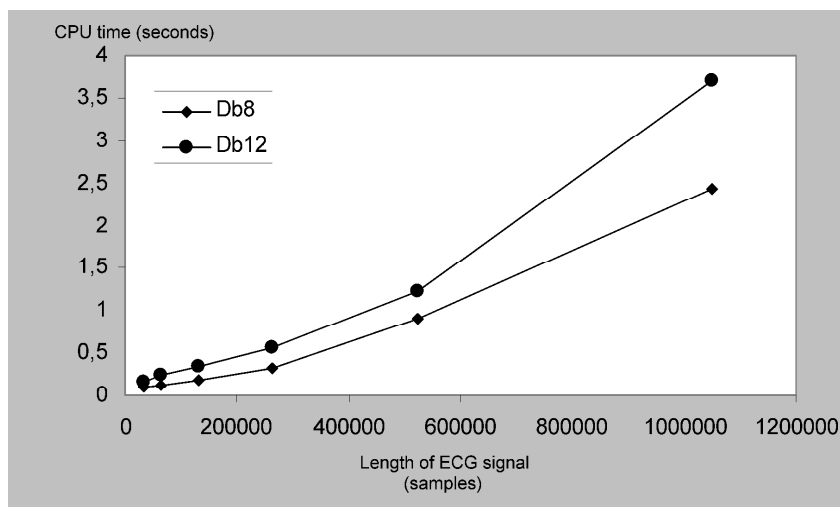

Figure 7. The CPU time for signals of different lengths for the proposed method

The conclusions based on the obtained experimental results from the proposed method are following:

1. The reconstructed signals have particularly good quality for further processing and can be successfully used for diagnosis.
2. Db12 wavelet basis is the optimal basis for the proposed method. Suitable bases are also Db4 and Db8.
3. Levels 3, 4 and 5 are the best levels of wavelet decomposition.
4. The CPU time for the denoising procedure (for 2^{20} samples signal length) with Db12 basis is 2.44 sec.

Comparative analysis of the wavelet based methods for denoising of ECG signals

Comparative analysis of the algorithms is performed on the parameters: Signal / Noise Ratio, Mean Square Error, PSNR, NMSE, RMSE, PDR, the needed CPU time and relationship between the Mean Square Error and standard deviation.

Table 4 Experimental Results

Algorithm	SNR	PSNR	MSE	NMSE	RMSE	PDR[%]
Decimation	10.077090	45.832712	0.015657	0.092827	0.086342	30.98
Hard thresholding	10.363888	45.225174	0.014720	0.085789	0.085789	30.32
Soft thresholding	11.147250	45.225174	0.012290	0.095600	0.078391	27.71
Adaptive thresholding, traditional	11.518588	11.518588	0.011283	0.070492	0.075110	26.55
Adaptive thresholding, proposed	12.67483	45.878939	0.008646	0.054015	0.065748	23.24

Table 4 shows the evaluated parameters for the analyzed above wavelet based methods. The algorithms with adaptive threshold show the best parameters. The proposed algorithm achieved the maximum Signal / Noise Ratio and minimum Mean Square Error.

Figure 8 presents the relationship between the MSE and the standard deviation σ . The results showed minimum MSE error with the adaptive threshold method. Therefore the adaptive algorithm is more effective than the algorithms with established threshold.

Figure 9 shows the obtained CPU time for the denoising procedure. The decimation algorithm is the fastest, but it is not accurate (see table 3).

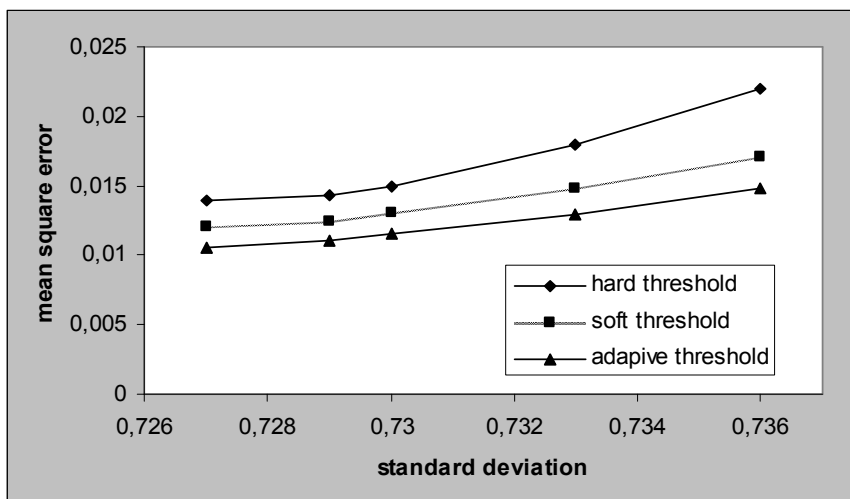

Figure 8. The MSE performance of hard, soft and adaptive methods

CONCLUSION

The Discrete Wavelet Transform allows successful denoising of the non-stationary electrocardiography signals. In the present paper a new relationship to finding the adaptive threshold has been proposed. Experimental testing of the new proposed threshold has been performed. Different electrocardiogram signals (from AHA ECG Database [13]) have been used to verify the described algorithm. The obtained results show that the proposed threshold is more suitable for ECG denoising than Donoho's threshold and can be successfully applied in the processing of the ECG signals.

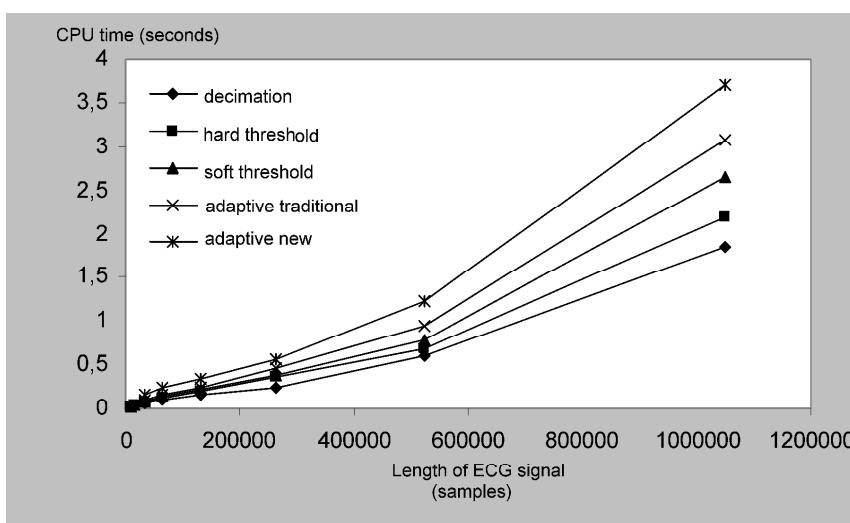

Figure 9. Performance of wavelet denoising methods

REFERENCES

- [1] Alfaouri M., K.Daqroug, ECG Signal Denoising by wavelet transform thresholding, American Journal of Applied Sciences, Vol . 5, No 3, pp.276-281, 2008.
- [2] Bruce G.A., Gao H.-Y. Understanding WaveShrink: variance and bias estimation. Biometrika, Vol.83, No 4, pp.727-745, 1996.
- [3] Donoho D.L., Denoising by soft thresholding. IEEE Transactions on Information Theory, Vol. 41, No 3, pp.613-627, 1995.
- [4] Donoho D.L., Johnstone I.M. Ideal spatial adaptation by wavelet shrinkage. Biometrika, Vol. 81, pp.425-455, 1994.
- [5] Gao H.-Y. Wavelet Shrinkage Denoising using the non-negative garrote. Journal of Computational and Graphical Statistics, Vol.7, No 4, pp.469-488, 1998
- [6] Gao J., Sultan H., Hu J., Tung W.-W. Denoising Nonlinear Time Series by Adaptive Filtering and Shrinkage: A Comparison. IEEE Signal Processing Letters, Vol.17, No 3, pp. 237-240, 2010.
- [7] Gospodinov, M., E.Gospodinova, Fractal Medical Image Compression. Proceedings of the International Conference on Automatics and Informatics, Sofia, Bulgaria, 3-7 October, pp. B307-B309, Proceedings: ISSN 1313-1850, 2011.
- [8] Gospodinova, E., M. Gospodinov, Multifractal Analysis of Digital Mammograms. Proceedings of the International Conference on Automatics and Informatics Sofia, Bulgaria, 3-7 October, pp. B303-B306, Proceedings: ISSN 1313-1850, 2011.
- [9] Kohler B.-U., C.Hennig, R.Orglmeister. QRS Detection using Zero Crossing counts. Progress in Biomedical research, Vol. 8, No. 3, pp. 138-145, 2003.
- [10] Poornachandra S., Kumaravel N. Subband Adaptive Shrinkage for Denoising of ecg Signals. EURASIP Journal on Applied Signal Processing, Vol. 1, pp.1-9, 2006.
- [11] Prasad V., Siddaiah P., Rao B.P. A New Wavelet Based Method for Denoising of Biological Signals. IJCSNS International Journal of Computer Science and Network Security, Vol. 8, No 1, 2008.
- [12] Zhidong Z., Min P., ECG denoising by sparse wavelet shrinkage. Bioinformatics and Biomedical Engineering. The 1st International Conference on, pp.786-789, 2007.
- [13] Harvard-MIT Division of Health Sciences and Technology Biomedical Engineering Center MIT-BIH Arrhythmia Database <http://www.physionet.org/physiobank/database/>

ABOUT THE AUTHOR

Assistant Prof. Galya Georgieva-Tsaneva, PhD student, Institute of System Engineering and Robotics, Bulgarian Academy of Sciences, E-mail: galicaneva@abv.bg.

Assistant Prof. Krassimir Tcheshmedjiev, Institute of System Engineering and Robotics, Bulgarian Academy of Sciences, E-mail: krassimir.j@gmail.com .